

Tennis Ball Launcher

Design & Construction, v1.20

Copyright 2004 - 2014



Table of Contents

Licensing 2

Disclaimer 2

Revision History 3

Introduction 4

Specifications 5

Special Considerations 6

Parts List 7

Before You Begin 11

Frame-Head Subassembly 12

Frame-Base Subassembly 14

Attaching the frame subassemblies 18

Motor Subassembly 19

Ball-feed Subassembly 25

Wiring 36

1. Licensing

This document is a copyrighted publication that contains intellectual property. You, the licensee are granted a single-use license for this material. The information contained herein is licensed to a single company, individual, or entity and may not be sold, shared, or otherwise distributed to any third party under any circumstances.

Any misuse of this material shall be considered a violation of the license agreement and copyright law. This material may be freely printed and/or copied so long as all such reproductions remain under the sole ownership and use of the licensee. It is the responsibility of the licensee to protect all reproductions under the terms and conditions of this agreement.

2. Disclaimer

While every effort has been made to ensure the validity of the material, the author shall not be held liable or responsible for content that may be inaccurate or outdated. The author shall not be held responsible for any damage or injury that may occur as a result of the use or misuse of the information contained in this document.

The licensee is responsible to follow proper safety precautions when working with tools, equipment, and machinery.

3. Revision History

The table below lists all document revisions:

Rev.	Date	Description
1.2	9/13/14	Corrected ball-speed error
1.1	4/6/14	Added detailed descriptions plus color photos
1.0	6/7/04	Initial baseline version

4. Introduction

This manual describes the tennis ball launcher and contains details regarding design, construction, and assembly.



Floor-stand



Table-top

The launcher consists of heavy-duty steel frame construction. It features swivel head (floor-stand model only), adjustable launch angle (floor-stand model only), dual drive motors, ball-feed mechanism, and durable 8" wheels, each with puncture-proof rubber treads and plastic hub. The 24 VDC motors are capable of 60+ MPH ball speeds.

5. Specifications

This section summarizes drive information, dimensions, and capacities for the tennis ball launcher.

- Measures 21"L x 21"W x 40"H
- Weighs 20 lbs
- Steel frame construction
- 8" solid rubber wheels
- Dual 12 / 24VDC motors
- Max ball speed 60+ MPH

Note: The launcher requires a 24 VDC power source, but can also be operated at 12VDC.

6. Special Considerations

Applicability:

The launcher exists in two models: floor-stand and table-top. This manual covers only the floor-stand model.

Ball-feed:

The ball-feed mechanism utilizes a hobby RC servo motor for feed activation. While this document describes mechanical installation and assembly of the mechanism, it does not describe servo wiring and control considerations. RC servos require a special electronics interface that is beyond the scope of this manual.

In the interest of demonstrating your completed launcher, you may wish to obtain a RC servo tester (pictured below). This device will allow you to manually operate the servo by rotating a knob on the tester. These devices are available from a number of retail suppliers including RC hobby stores and independent outlets, some costing as little as \$10. (Servo testers require a suitable power source, typically 4.8VDC to 6VDC. Consult the retail supplier and/or appropriate documentation for details.)



RC Servo Tester

7. Parts List

The following tables contain part information associated with the tennis ball launcher. This information lists suppliers, required quantities, part numbers, approximate cost, and descriptions. (In some instances a part number is not provided. These items are commonly available in many hardware and home improvement stores.) You will also find notes which describe how the part is used and any special considerations.

While every effort has been made to provide reliable data, we cannot guarantee the information's accuracy since suppliers frequently change their inventory without notice. We cannot assume responsibility for modified pricing, stock issues, or discontinued parts. If you encounter difficulty locating a part, contact us at support@kadtronix.com and we will do our best to suggest an alternate supplier, if possible.

Parts List					
<i>Item</i>	<i>Qty.</i>	<i>Supplier(s)</i>	<i>Cost Each</i>	<i>Notes</i>	<i>Description</i>
1	1	harborfreight.com	\$25	F,4	Mechanic's roller seat, #3338
2	1	harborfreight.com	\$20	F,8	Adjustable roller stand, #46086
3	1	mcmaster.com	\$2	F	Eye-bolt, 1" eye dia., 4" shank, 2-1/2" thread len, 1/2-13 threads, #9489T39
4	4	see note(s)	-	F,1	Hex nut, 1/2"-13
5	2	see note(s)	-	F,1	Washer, 1/2"-13
6	2	see note(s)	-	F,1	Fender washer, 1/2", (1-1/4" O.D.)
7	1	see note(s)	-	F,1	Hex bolt, 1/4" x 4" long
8	2	see note(s)	-	F,1	Hex bolt, 1/4", 1-3/4" long
9	4	see note(s)	-	F,B,1	Hex nut, 1/4"
10	10	see note(s)	-	F,B,1	Washer, 1/4"
11	4	see note(s)	-	F,B,1	Lock washer, 1/4"
12	3	see note(s)	-	F,B,1	Nylon spacer, 1/4" screw size, 1" long, #67341727
13	2	northerntool.com	\$10	W	Wheel, 8" x 1.25", solid rubber tire, #155124
14	2	mcmaster.com	\$1	W,1,3,5	Hex coupling nut, 5/16"-18, 7/8" long, 1/2" wide, #90264A445
15	2	see note(s)	-	W,1	Hex bolt, 5/16-18", 1-3/4" long
16	2	see note(s)	-	W,1	Washer, 5/16"
17	2	see note(s)	-	W,1	Lock washer, 5/16"
18	2	electricscooterparts.com	-	M,6,7	Electric scooter motor, 24VDC, 2650 RPM, 250W, mounting bracket, chain sprocket, retaining nut, #MOT-24250X2650 or #MOT-24250X2500
19	4	see note(s)	-	M,1,2	Mounting u-bolt & plate, 1/4"-20 x 1-3/8" pipe
20	4	see note(s)	-	M,1,3	Screw, pan-head, phillips, metric, M6, 35mm long, 1mm pitch
21	4	see note(s)	-	M,1,3	Screw, pan-head, phillips, metric, M6, 10mm long, 1 mm pitch
22	-	see note(s)	-	M,1	Electrical wire, 14 ga. or larger, 5 to 10 ft. length
23	-	see note(s)	-	M,1	Electrical tape

Parts List					
24	-	see note(s)	-	M,1	Rubber sheet/mat or non-slip shelf liner, 1/16" to 1/8" thick, roughly 1" x 2" size (to be cut into four 1" x 1/2" strips)
25	1	alvinco.com	\$16	B	Transparent document tube, 2-3/4" I.D. x 25", Alvin Ice Tube, #MT25-GR
26	1	towerhobbies.com	\$15	B	RC servo motor, Hitec HS-311, #LXDEL5
27	1	see note(s)	-	B,1	Hex bolt, 1/4", 3" long
28	9	see note(s)	-	B,1	Cable-tie straps (sizes: 6 small, 3 medium)
29	-	see note(s)	-	B,1	Galvanized wire, general purpose, 14 ga., 12" length
30	1	mouser.com	-	B	Enclosure, Hammond 1594BBK, #546-1594B-BK

Legend	
F	Frame/chassis assembly
M	Motor assembly
W	Wheel assembly
B	Ball-feed assembly

Notes:	
1	This is a common item available at many local hardware stores and DIY outlets. Recommended suppliers include Ace Hardware, Home Depot, Lowes, and others. (Note: While we make every effort to provide reliable information, please keep in mind that supplier inventory can change without notice. We make no guarantee that any item is available with a given supplier or is even listed in the supplier's regular inventory.)
2	U-bolt plates secure the motors to the steel frame. Only the plate is needed - you may discard the u-bolt. (Note: Rounded corners are recommended to prevent injury. If you purchase plates with square corners, use a file or other tool to round them off.)
3	The minimum length has been specified. Slightly longer lengths are acceptable.

Notes:	
4	<p>Components of the mechanic's roller seat will be used to form the frame head (the upper portion of the launcher that supports the motors). Only the following parts of the roller seat are needed:</p> <p style="margin-left: 40px;">Qty Part name*</p> <p style="margin-left: 40px;">-----</p> <p style="margin-left: 40px;">1 Base frame</p> <p style="margin-left: 40px;">1 Reinforcement bar</p> <p style="margin-left: 40px;">2 Support frame (optional, needed only if building the table-top model**)</p> <p>* Refer to the roller seat user manual to properly identify these components. The user manual is included with purchase of the roller seat.</p> <p>** Details for building the tennis ball launcher table-top model are not covered in this manual.</p>
5	<p>One end of the coupler accepts a 5/16" hex bolt which acts as a wheel retainer. The other end mates directly to the threaded motor shaft. (Since the threads on the motor shaft may not match the coupler's thread pitch, cross-threading may be necessary. This is perfectly acceptable and will not adversely affect operation of the launcher.)</p>
6	<p>Rated for 24VDC, but also runs well at 12VDC.</p>
7	<p>This motor is available in several varieties and with a range of attributes. The launcher specifically requires a unit with the following attributes:</p> <ul style="list-style-type: none"> - 250 watts - Threaded shaft - Chain sprocket - Sprocket retaining nut - Mounting bracket with 4 threaded mounting holes <p>Units having similar specs may be acceptable, but are not guaranteed to be compatible with the launcher system.</p>
8	<p>The adjustable roller stand provides the floor base for the launcher. Only the following parts of the roller stand are needed:</p> <p style="margin-left: 40px;">Qty Part name*</p> <p style="margin-left: 40px;">-----</p> <p style="margin-left: 40px;">1 Tripod stand</p> <p style="margin-left: 40px;">1 Vertical tube</p> <p>* Roller and related items (support bar & mounting brackets) are not needed for the launcher and may be discarded. Refer to the roller stand user manual to properly identify these components. The user manual is included with purchase of the roller stand.</p>

8. Before You Begin

This project requires medium to advanced experience with mechanical assembly and fabrication. While expert skill is not required, the novice might find portions of the project somewhat challenging and should seek appropriate assistance whenever as necessary.

Prior to beginning construction, you are advised to carefully review the entire document to become thoroughly familiar with the project. This is the time to assess your skills and to determine where you might encounter difficulty. This is also the time to take inventory of your tools and parts. There's little more frustrating than beginning a project and discovering you cannot complete it because of a critical missing item.

Project build time will vary and depends on available tools and your experience level. Roughly speaking, you should be able to complete the mechanical assembly in about 5 to 10 hours. This estimate assumes an average mechanical ability and a standard set of tools as listed below.

Before beginning this project, refer to the parts lists provided earlier. Make sure you have all the required items handy. Use proper care and patience at all times. Drilling an improperly sized hole or making a miscalculated cut could result in damaged parts and ruin the project. Read through all the instructions in this manual carefully before beginning.

Caution: Be sure to follow proper safety procedures at all times. And always use protective eye wear.

The following tools are needed for construction and assembly of this project:

- Power drill plus bits (1/8", 1/4", 5/16")
- Wrench
- Pliers
- Vice-grip locking pliers
- Wire cutters / strippers
- Screwdrivers: Philips and flat-blade
- Scissors or shears
- Hacksaw
- File

Additional items you may wish to have on hand include the following:

- Masking tape

9. Frame-Head Subassembly

The frame-head subassembly is the upper portion of the launcher that supports the drive motors and ball-feed elements. It attaches to the frame-base subassembly and consists of welded steel tubing. The frame-head is derived from a mechanic's roller seat as shown in the photo below-left. (Refer to item #1 in the parts list for supplier information.)



Only the following components of the roller seat are needed:

- Base frame
- Reinforcement bar
- Support frame (optional - needed only if building the table-top model **)

* Refer to the roller seat user manual to properly identify these items. The user manual is included with purchase of the roller seat. (You may ignore the prescribed assembly instructions contained in the roller seat manual.) Unused roller seat items will not be needed and may be discarded or saved for another project.

** The table-top model is not covered in this manual.

Retrieve the listed items from the roller seat box. You will find that the base frame has a number of pre-drilled holes. While some of these holes will be utilized for the launcher project, an additional hole is required as shown highlighted in the photo below:

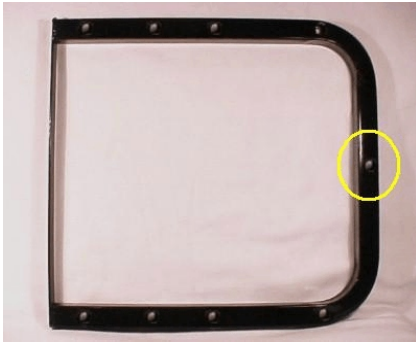

Drill a 1/4" diameter hole at the middle of the frame segment as shown above. (The hole must be drilled completely through the frame tubing.)

Note: Before drilling, you may wish to apply lengths of masking tape around the frame's perimeter to minimize the possibility of scratching or damaging the paint finish.

Apply the reinforcement bar as shown in the photos below and secure each end with hex bolt, nut, washer, and lock-washer (items 8, 9, 10, & 11):



10. Frame-Base Subassembly

The frame-base subassembly is the lower portion of the launcher. It consists of a tripod stand which provides support for the frame-head subassembly. The frame-base subassembly is derived from an adjustable roller stand as shown in the photo below-left. (Refer to item #2 in the parts list for supplier information.)



Adjustable Roller Stand



Tripod Stand



Vertical Tube

Only the following components of the roller stand are needed:

- Tripod stand
- Vertical tube
- Related screws and other fasteners

* Refer to the roller stand user manual to properly identify these items. The user manual is included with purchase of the roller stand. Roller and related items (support bar & mounting brackets) are not needed for the launcher and may be discarded or saved for another project. Retrieve the listed items from the roller stand box.

Drill a 1/4" hole into the bottom of the vertical tube, located roughly 3/8" from the end as shown below:



Assemble the tripod stand using the instructions contained in the roller stand user manual. Then insert the vertical tube.

Note: The tube must be inverted (turned upside down) such that the bottom end with the newly drilled hole extends up through the top of the tripod stand. The finished frame base is shown below:



Obtain two (2) fender washers (item #6) and bend using pliers as shown below:



Obtain eye-bolt (item #3) and apply the following fasteners.

- Four (4) nuts (item #4),
- Two (2) washers (item #5)
- Two (2) fender washers (item #6)

Assemble the eye-bolt and related fasteners as depicted in the photos below:

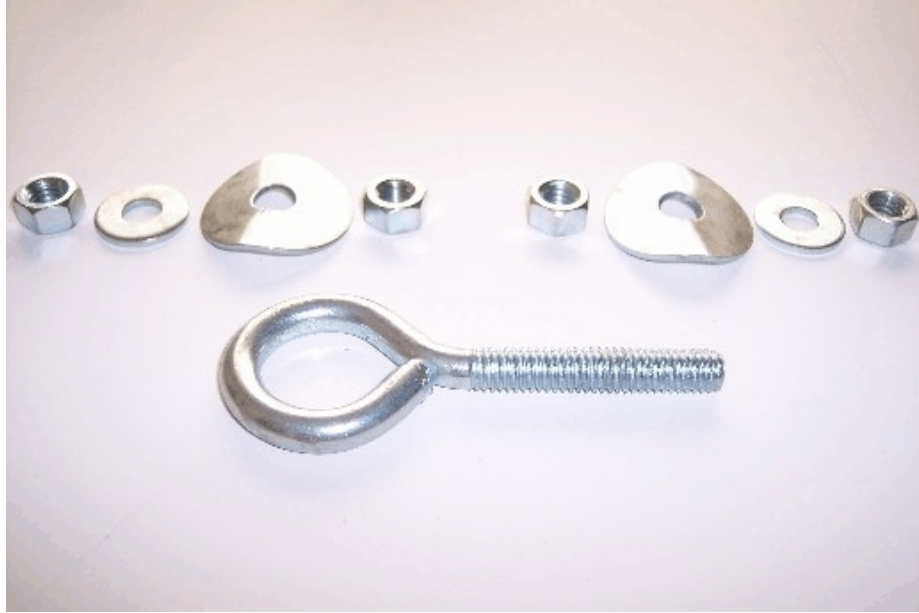

Next, slip the completed bolt assembly onto the vertical tube of the tripod stand in preparation for attaching the frame-head assembly.

Obtain a long bolt (item #7) and the following fasteners.

- Nylon spacer (item #12)
- One (1) nut (item #9)
- Three (3) washers (item #10)
- One (1) lock-washer (item #11)

The photos below show the required items. (Do not assemble the bolt and fasteners at this time.)

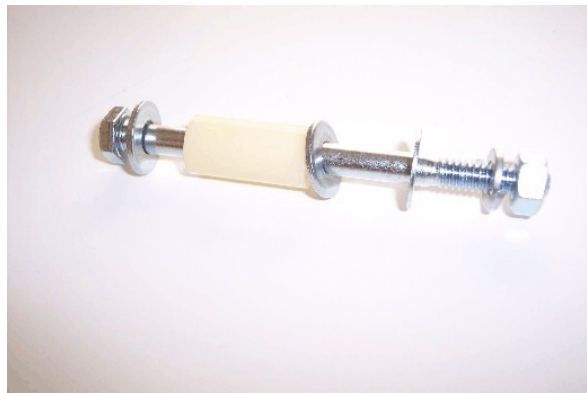
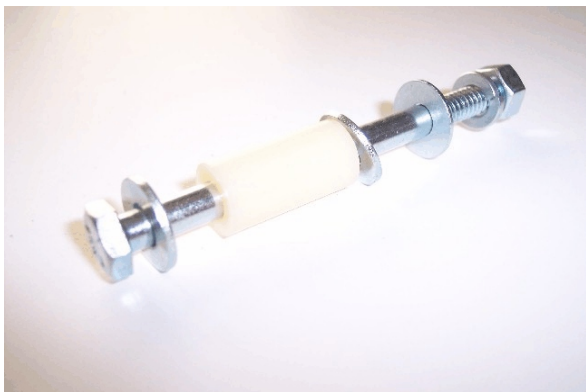

The long bolt will be used to attach the two frame subassemblies together.

11. Attaching the frame subassemblies

Now that the frame-head and frame-base subassemblies are complete, you are ready to combine them to form a single frame assembly. Aligning the holes that you previously drilled in the frame-head and vertical tubes, apply the long-bolt and fasteners as shown in the photos below.



Notes:

- Washers are applied against each metal surface. A lock-washer is applied between the nut and vertical tube.
- The frame-head should be oriented such that the reinforcement bar faces away from the vertical tube.

Secure the bottom of the frame-head to the vertical tube using the eye-bolt assembly as shown:



12. Motor Subassembly

Two electric motors (item #18) are required for the launcher.

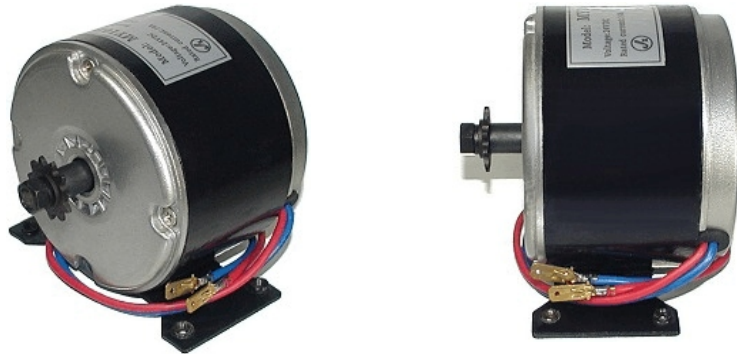

One motor will be mounted to the upper section of the frame-head while the other will be attached to the lower section. The following hardware is required for mounting each motor to the frame and attaching a wheel to the shaft:

- Two (2) U-bolt plates (item #19)
- Four (4) 35 mm screws [upper motor] (item #20)
- Four (4) 10 Mm screws [lower motor] (item #21)
- Two (2) rubber strips (item #24)
- Hex bolt (item #15)
- Washer (item #16)
- Lock-washer (item #17)
- Two (2) wheels (item #13)

The shaft contains a small chain sprocket with retaining nut as shown below:



Use locking pliers firmly attached to the sprocket to immobilize the motor shaft. Then use a wrench to remove the retaining nut, leaving the sprocket in place. Attach hex coupling nut (item #14) as shown below (right):

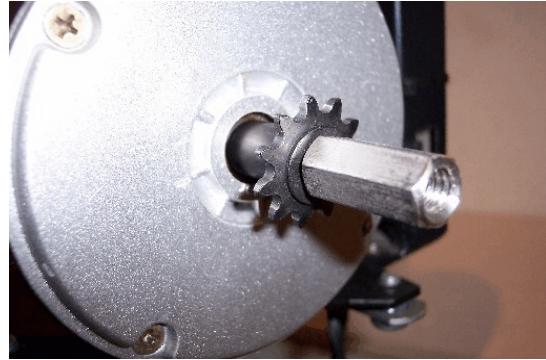
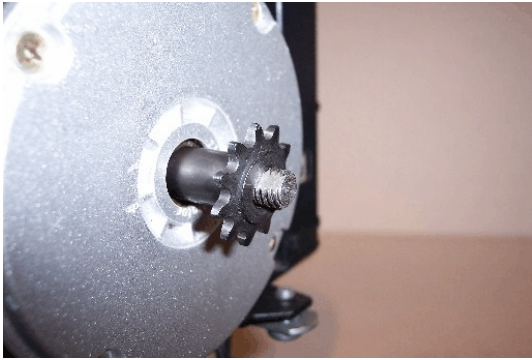

Note: Since the threads on coupler may not match the thread pitch of the motor shaft, cross-threading may be necessary. This is perfectly acceptable and will not adversely affect motor operation.

Prepare to install a wheel onto the motor shaft by first removing one of the wheel's two bearings. (The bearing can be easily removed by inserting a screwdriver through the opposite end of the hub and tapping around the perimeter of the bearing with a hammer.)

Note: Only one of the two bearings it to be removed.



Wheel with bearing



Opposite side: bearing removed, exposing an open hub

Place the wheel onto the motor shaft & coupler. Center the wheel, resting the open hub against the motor sprocket.

Next, apply retaining fasteners consisting of bolt (item #15), washer (item #16), and lock-washer (item #17) to secure the wheel to the motor shaft. Thread the bolt into the coupler, using a wrench to tighten it. This action will cause the sprocket to become partially embedded into the hub.



Note: As the shaft retaining bolt is tightened, the motor sprocket will be pressed into the soft plastic of the hub, locking the wheel so that it is unable to slip during shaft rotation. The photo below shows the hub's appearance after a sprocket has been pressed into it and the wheel subsequently removed. (This photo is provided for informational purposes only. It is not necessary to remove the wheel once the shaft retaining bolt has been applied.)



The photo below shows the wheel with applied retaining fasteners.



Use U-bolt plates (item #19) and screws (items #20 & #21) to attach the motors to the frame-head. The photo below (left) shows a U-bolt plate. The photo (below, right) shows the plate with screws



Notes:

- Only the U-bolt plate is needed. The U-bolt itself (not shown) is not required and may be discarded.
- Use plates with rounded corners to prevent inadvertent cuts and scratches. (Plates with square corners may be used if desired, but should be filed for safety.)

9/13/14

The photos below show how to attach the motors to the frame-head. Longer screws (item #20) are used for securing the upper motor while shorter screws (item #21) secure the lower motor.

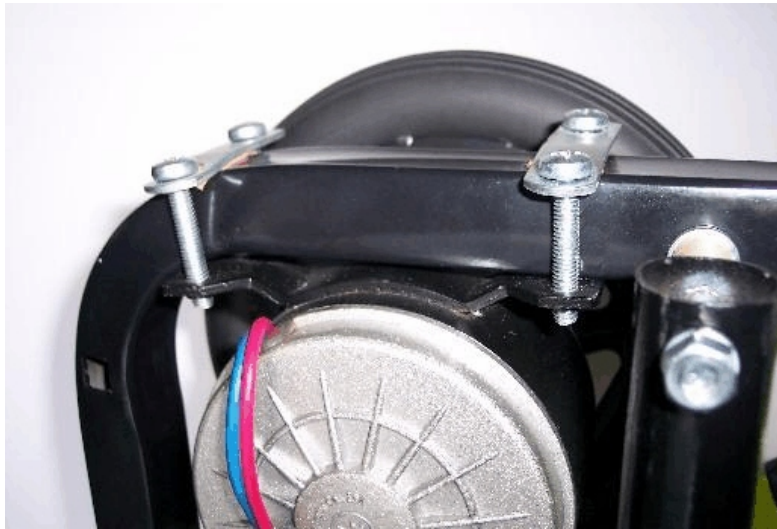

Upper motor



Lower motor

Note: Rubber strips (item #24) are inserted beneath each U-bolt plate. These strips are necessary to prevent the motor from sliding or shifting on the smooth frame surface.

The frame assembly with attached motors & wheels should resemble the image depicted below:



13. Ball-feed Subassembly

The ball-feed system is comprised of the following components:

- Clear document tube (item #25)
- RC servo motor (item #26)
- Hex bolt (item #27)
- Hex nuts (item #9)
- Washers (item #10)
- Lock washers (item #11)
- Nylon spacers (item #12)
- Cable-tie straps (item #28)
- 14 gauge wire (item #29)
- Small enclosure (item #30)

When used with a compatible control electronics (see note), the system can automatically dispense up to three (3) tennis balls.

Note: Automatic ball-feed control requires a specialized control system and is not covered in this manual. For an alternative control method, refer to “Special Considerations”.

Obtain a clear plastic tube (item #25) and modify as shown in the diagrams below:

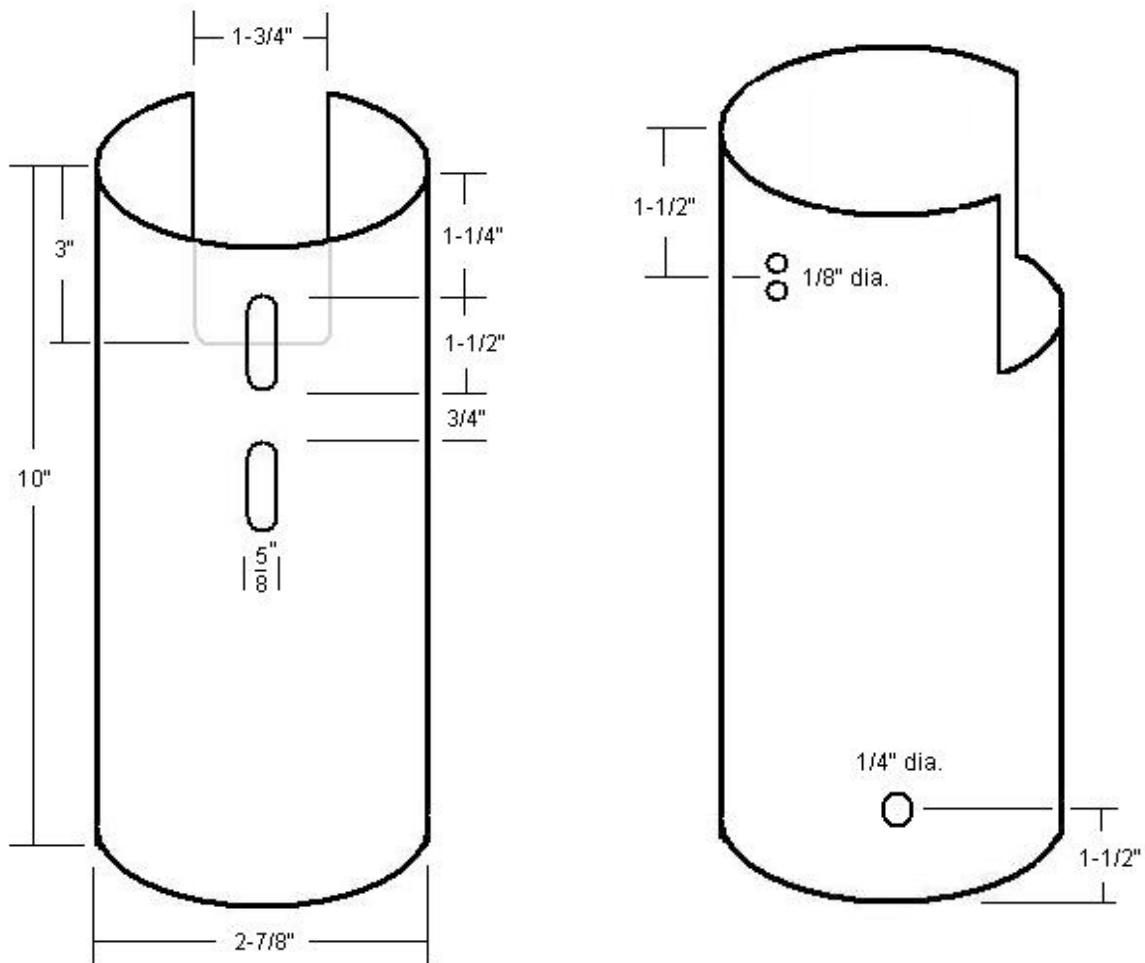

Note: The images above show the wheel-slot at the upper end of the tube and the 1/4" diameter hole at the lower end. When installed to the launcher, the tube will be inverted such that the wheel-slot will be at the lower end.

After modifying the tubes appropriately, insert hex bolt (item #27) through the upper end of the tube (denoted by the 1/4" hole), applying nylon spacer (item #12). Attach to the frame-head, applying two (2) washers (item #10). Secure with nut (item #9) and lock-washer (item #11).

Note: Apply washers on either side of the frame tubing. Apply a lock-washer in front of the hex nut.

Note: It may be necessary to enlarge the 1/4" hole in the tube in order to properly insert the bolt through the tube opening.



9/13/14

The lower end of the tube requires a modified nylon spacer (item #12). Drill a 1/8" hole through the side of the spacer as shown. (Precise location of the hole is not required..)



Note: The hole must be drilled completely through the spacer.

Secure the lower end of the tube to the reinforcement bar using small cable-tie strap (item #28) and modified spacer. Insert the cable-tie through the two 1/8" holes in the tube, into the spacer, and around the reinforcement bar as shown in the photos below:

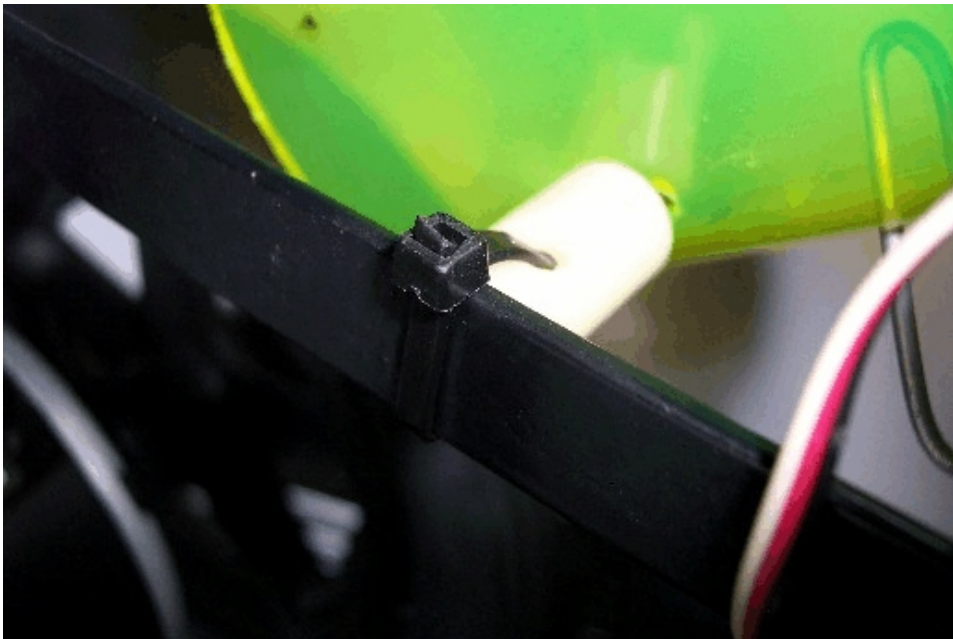
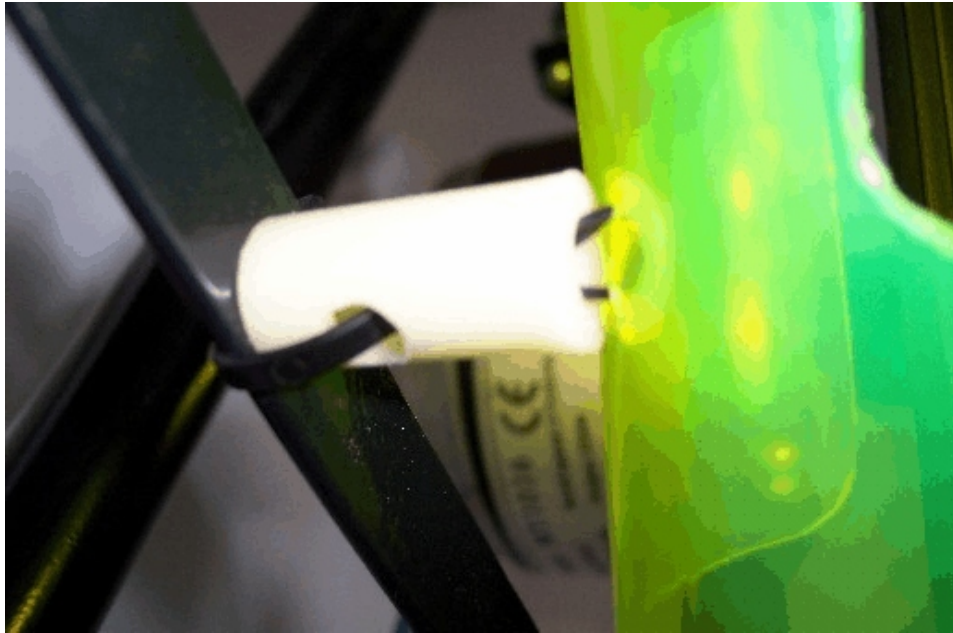

9/13/14



A servo motor actuator (item #26) is needed for performing the ball-release function. The photos below show a servo that features a circular control horn. Held in place by a retaining screw, the control horn provides a convenient method for attaching the motor shaft to an external linkage.

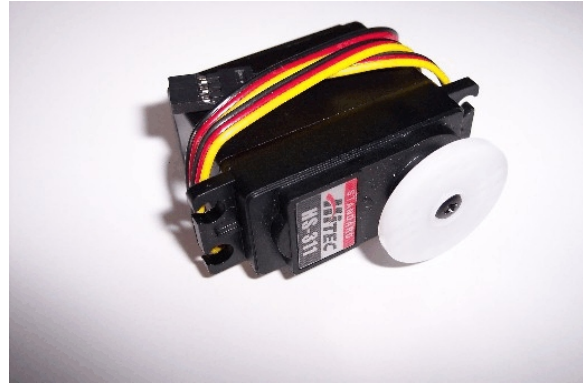
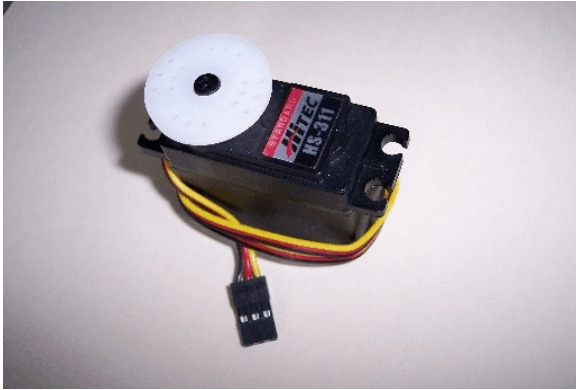

The servo includes a variety of different control horns as shown below. Use a screwdriver to remove the retaining screw and replace with the circular horn with the one that is highlighted in the photo.



Next, use a length of galvanized wire (item #29) to create ball-release prongs as shown in the images below. Use pliers to create each bend in the wire. Use a hacksaw or heavy-duty shears to cut the wire as needed.

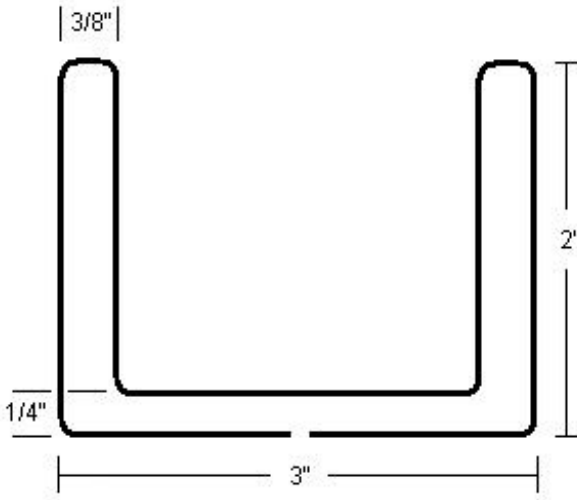

Apply the ball-release prongs to the servo motor shaft as shown below using appropriate control horn. Secure with retaining screw.

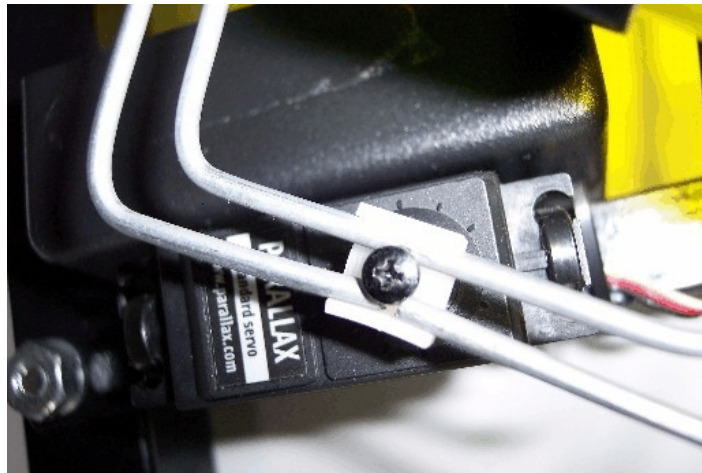

Attach the servo motor assembly to the reinforcement bar using two (2) medium size cable-tie straps (item #28) as shown:

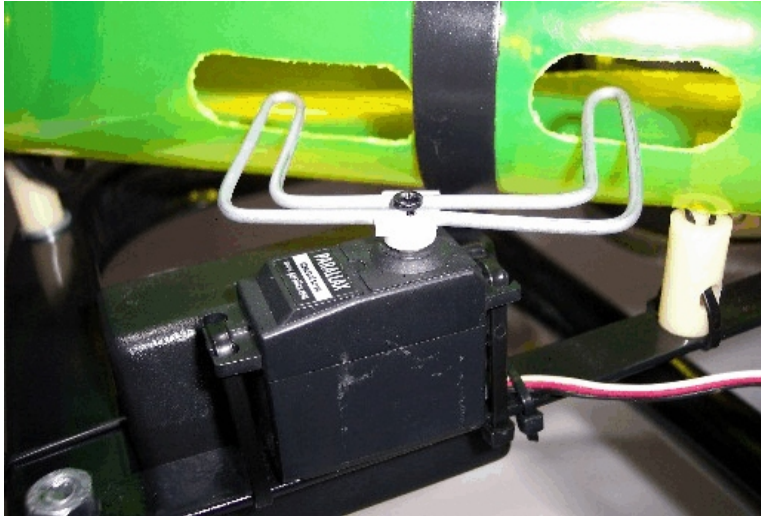

Servo (top view)

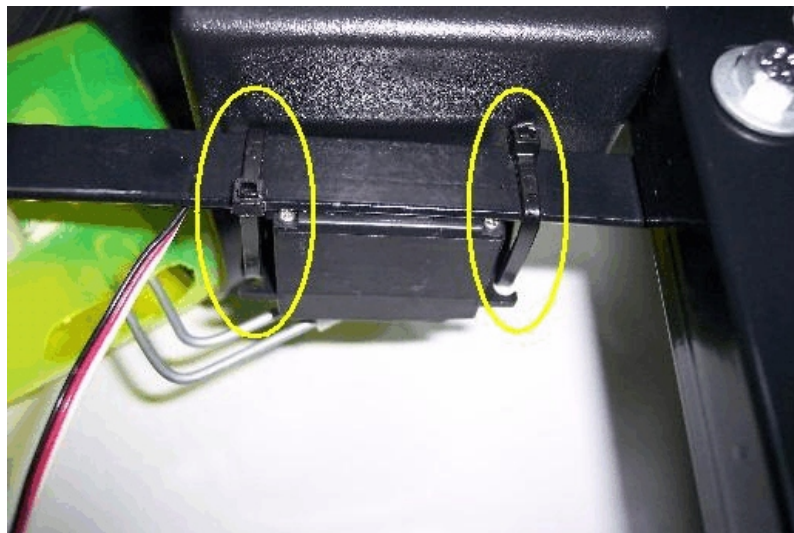

Servo (bottom view)

Obtain a small plastic enclosure (item #30) to be used as an accessory box. This item provides housing for optional servo control electronics, switch, or other small item. The box mounts atop the reinforcement bar and sits adjacent to a vertical support of the frame-head. Drill four (4) holes into the enclosure as shown below. These holes will be used to secure the box using cable-tie straps (item #28).

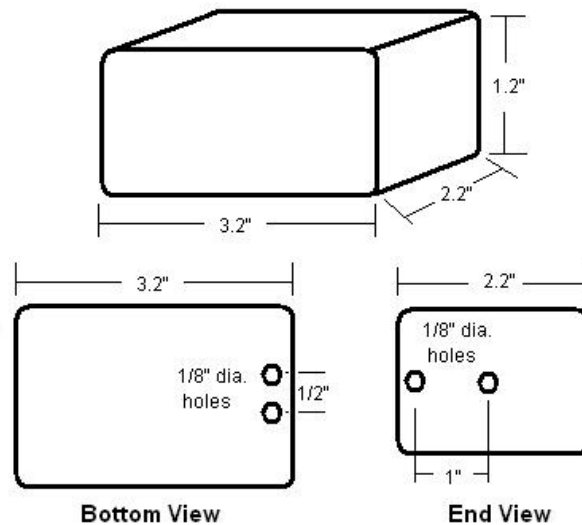

Use a small cable-tie strap (item #28) to secure the box to the vertical frame support as shown in the photos below. (If a single strap is not long enough, use a longer strap or attach two smaller straps end-to-end.)

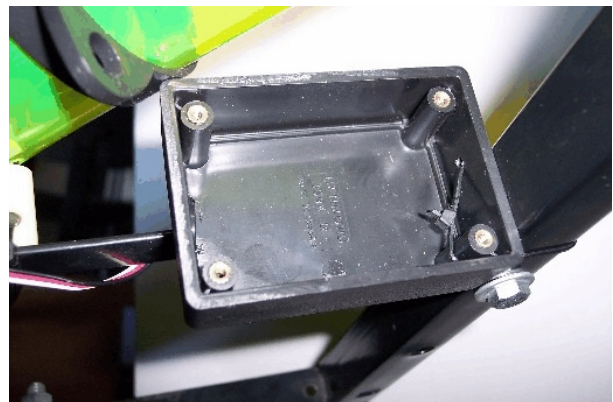

Also apply a small cable-tie strap to secure the box to the horizontal reinforcement bar as shown below. The left strap (shown highlighted) wraps around the reinforcement bar while the right strap (also highlighted) encircles the adjacent vertical frame section.

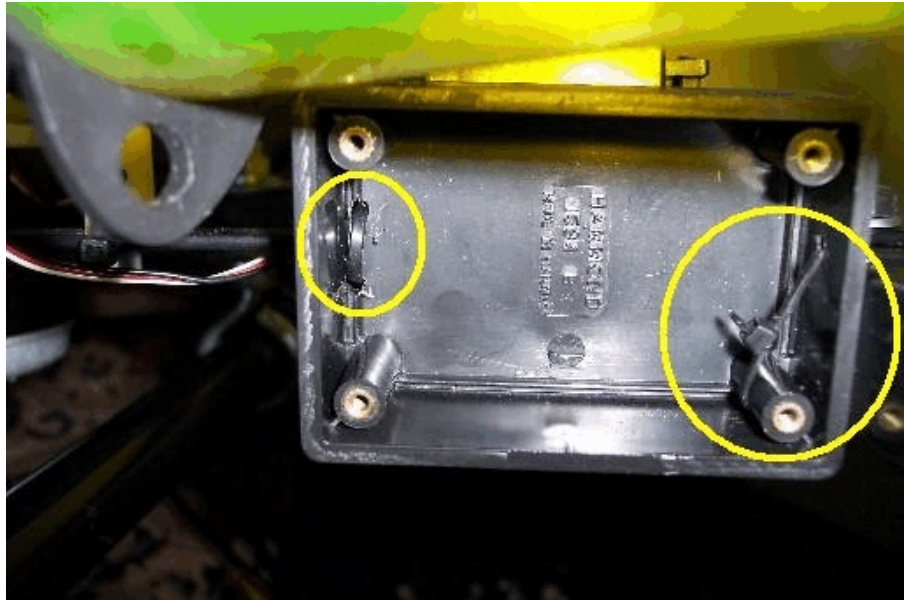

The photo below is a view of the underside of the accessory box and highlights the strap's attachment around the reinforcement bar.



14. Wiring

Once the mechanical assembly has been completed, you may focus on system wiring. The schematic diagram below illustrates the proper connections for activating the motors. Use appropriate lengths of wire, being careful to note proper polarities.

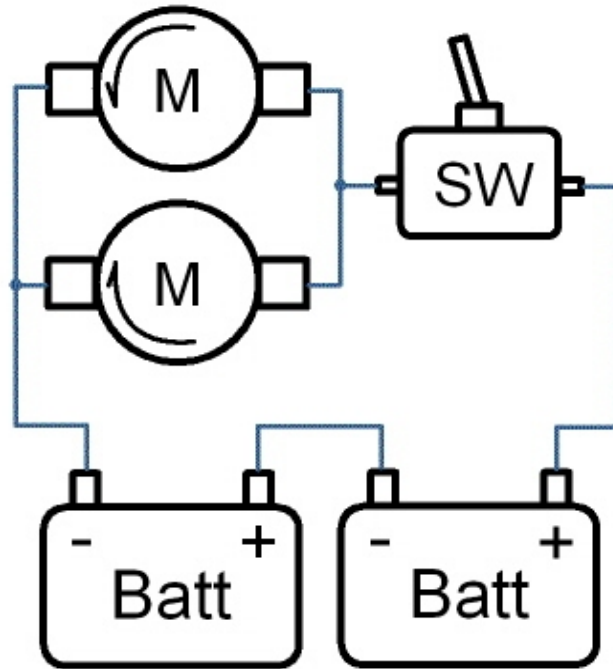

There are a range of possible options for powering the motors. Gel cell batteries are widely available and fairly inexpensive. To achieve the 24 volts DC required by the motors, you may wish to obtain two (2) 12VDC gel cell batteries and wire them in series as shown. A compatible charger is also recommended.

Notes:

- 1) Use wire that is sized large enough to handle the maximum current draw of both motors running concurrently. For most applications, 14 gauge wire should be sufficient. (More powerful motors may require a heavier wire size.)
- 2) Motors must be wired such that they spin in opposite directions (i.e., one motor spins clockwise and the other counter-clockwise). To determine spin direction for each motor, temporarily connect the motor leads to the battery. To reverse spin direction, simply reverse the motor lead connections.

Caution: Check the motor specs to ensure that reversed voltage is allowable.

3) If the motors require a higher voltage than can be provided by a single battery, consider using multiple batteries wired in series as shown.

4) If using rechargeable batteries, be sure to obtain a compatible charger and follow charging directions carefully.

Congratulations!

You have completed the Tennis Ball Launcher.

